

4K UHD ALL-IN-ONE USB Camera User Manual

1 Safety Precautions

- During the installation and operation, all electrical safety regulations of the country and region of use must be strictly observed.
- Please use the power adapter that comes standard with this product.
- Do not connect multiple devices to the same power adapter (exceeding capacity of the adapter may generate excessive heat or cause fire).
- Do not rotate the camera by hand, otherwise it may cause mechanical failure.
- When installing this product on a wall or ceiling, make sure the device securely and there are no obstacles within the rotation range; Do not power on until all installations are completed.
- To avoid heat build-up, please keep smooth ventilation around the device.
- If the device smokes, smells, or makes noises, please turn off the power and unplug the power cord immediately, then contact the dealer in time.
- This device is not waterproof, please keep the device dry.
- This product has no user serviceable parts, damage caused by disassembly by the user is not covered by the warranty.



Warning
Operating this equipment in a residential environment may cause radio interference.

2 Packing List

Name	Quantity	Name	Quantity
Camera	1	USB Cable	1
Power Adapter	1	Wall Bracket (with screw)	1
Power Cable	1	User Manual	1
Remote Control	1	-	-

3 Appearance and Interface

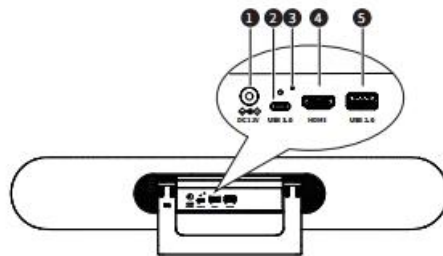

No.	Name	No.	Name
1	DC 12V Interface	4	HDMI Interface
2	USB 3.0 Interface	5	USB 2.0 Interface
3	Reset Button	-	-

4 Product Features

Applicable Scene

It is specially designed for small and medium-sized meeting rooms, especially for the Huddle Room with 4 to 6 people, to help enterprises re-tap the potential of using the small and micro meeting space inside. On one hand, it can hold meetings more efficiently, on the other hand, it can also save the rental cost.

Product Value

It is convenient for small and medium-sized enterprises to conduct daily business negotiation and team cooperation in different places flexibly, so as to create a relaxed, free and smooth conversation environment, make decisions quickly and improve efficiency.

All-in-one Design

The three-in-one design of 4K ultra HD camera, beamforming microphone and full-frequency loudspeaker reduces wiring and make video communication easy.

Bluetooth 5.0

Using Bluetooth 5.0 technology. Compared with the previous generation technology, the transmission rate is increased by 2 times, and the transmission distance is increased by 4 times. It can better transmit the high-quality audio between the mobile phone and tablet devices to achieve the wireless Bluetooth streaming.

4K UHD

Using 1/2.5 inch, 8.51M pixel high quality UHD CMOS sensor, 4K (3840x2160) ultra high resolution clear image, and downward compatible with 1080P, 720P and other resolutions. It can meet the needs of users for different video experiences, and can provide clearer, real, smooth and accurate video communication.

Wide Field View

121° wide field of view (110° horizontal field of view), 5 times zoom, optical lens customized for the conference scene, built-in electric head (horizontal and pitch ±15° motion range), no need to worry about the camera position, participants can easily enter the scene clearly.

Beamforming Microphone

Beam Forming (BF) microphone is built in, with a pickup distance of 6 meters. Low-distortion transverse beamforming algorithm can direct the microphone directly to the speaker, with better sound, clearer communication, fuller and more authentic.

Audio 3A Algorithm

Built-in audio 3A algorithm (AEC/AGC/ANS), full duplex dialogue, can meet the communication needs of different room structures, whether sitting at a conference table, sitting against the wall or standing, can have comfortable experience for calling.

Full Frequency Speaker

Full frequency Hi-Fi loudspeaker, professional acoustics design, reduce noise interference, provide outstanding sound effect.

Plug and Play Type

Through plug and play USB interface connect with the computer or business display screen, very easy to use. Less wiring, convenient video communication, reduce the user's learning cost.

Speaker Phone

It can be used as Bluetooth microphone and speaker while connected to mobile phone or other devices via Bluetooth connection, and the call can be connected to the audio and video conference.

Intelligent Analysis

Built-in intelligent analysis algorithm, listening to the speaker position, automatic framing of participants, automatic tracking of speakers, switching the speaker screen, to ensure that the speaker is always clearly in the picture.

Multiple Interfaces

Support HDMI and USB 3.0 audio video output simultaneously.

Easy Installation

Flexible installation options such as desktop, wall, and TV/display screen are available for quick installation and deployment in a crowded meeting room.

5 Product Specifications

Camera	
Video System	4K30, 1080P30, 720P30, etc
Sensor	1/2.5-inch, CMOS, 8.51M pixel
Lens	121° (DFOV), 110° (HFOV), 5x Digital Zoom, Pan/Tilt ±15°
PTZ	MPT+PTZ
Digital Noise Reduction	2D&3D Digital Noise Reduction
Video SN	≥ 55dB
Backlight Compensation	Support
Audio	
Full Frequency Speaker	96dB SPL in the case of 0.5 meter
Microphone Array	Beamforming microphone, pick-up distance up to 6m
Extended MIC	Support
USB Features	
Connection Type	USB 3.0, downward compatible with USB 2.0
Video Compression	MJPEG/H.264
USB Audio	32K sampling rate, support UAC 1.0
USB Protocol	UVC 1.1
UVC PTZ Control	Support
Interfaces	
Video Interface	1 x HDMI, 1.4b
USB Interface	1 x USB 3.0, Type-C
	1 x USB 2.0, Type-A
Power Interface	DC 12V, 2A (max.)
General Specifications	
Control	2.4G Remote Controller
Installation	Desktop, Wall, TV and others
Operating Temperature	0°C~40°C
Storage Temperature	-40°C~60°C
Dimension	600mm x 115.5mm x 135mm (with bracket)
Net Weight	About 2.5kg



Note
Product features and specifications are subject to change without notice.

6 Product Dimension

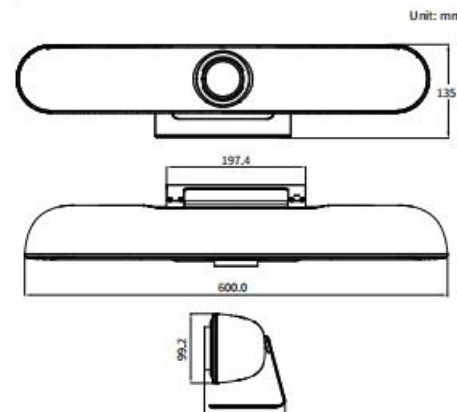

7 Installation and Connection

7.1 Installation

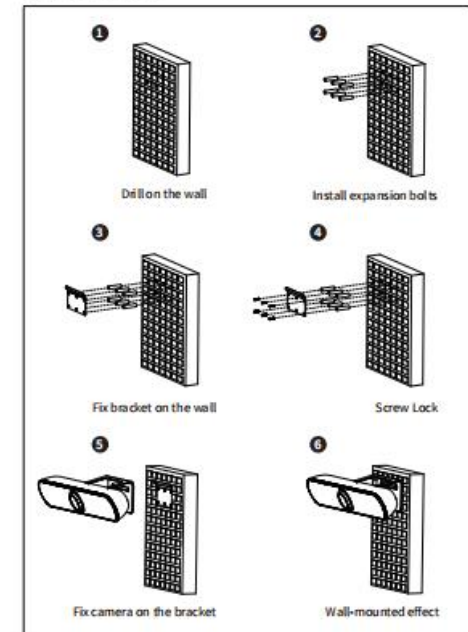

Note
The installation diagram is for reference only, please refer to a actual product for the installation accessories.

7.2 Connection

The cable connections shown in the following figure contains optional configurations and for reference only. Please connect the cables according to actual needs.

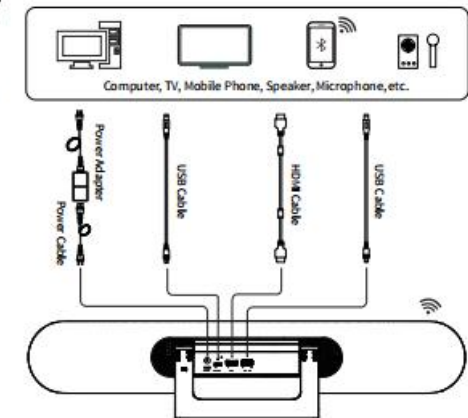

8 Remote Control

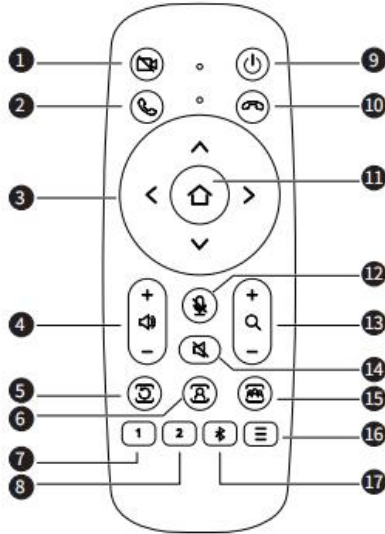

No.	Name	Function Description
1	Camera Close Key	Press to turn off the camera, press again to resume
2	Call Key	Answer the call
3	Direction Keys	Press to move the camera to up, down, left and right directions; press the [OK] key to turn the camera back to the middle position
4	Volume +/- Keys	Press to increase or decrease the volume
5	Exit Tracking Key	Press to exit the tracking mode
6	Speaker Tracking Key	Press to enable the speaker tracking function
7	Preset 1 Key	Long press to set preset 1; short press to call preset 1
8	Preset 2 Key	Long press to set preset 2; short press to call preset 2
9	Standby Key	Long press camera enter to standby mode; short press to resume
10	Hang Up Key	Hang up the call
11	OK Key	Confirm selection
12	Mute Key	Turn on/off the microphone
13	Zoom Keys	Zoom in [+]; Zoom out [-]
14	Speaker Mute Key	Turn on/off the speaker
15	Participants Tracking Key	Press to enable the participants tracking function
16	Menu Key	Press to enter or exit the OSD menu
17	Bluetooth Key	Enable/Disable the Bluetooth function

9 Pairing

The remote control has been paired before delivery. If you need to pair it again, please refer to the following steps:

- Step 1** Connect the camera to the power supply, wait for the initialization to complete, and the camera can output pictures normally.
- Step 2** Clear the paired status:
Press and hold the [MENU] + [OK] key at the same time until the indicator of remote control lights with steady red.
- Step 3** Enter the pairing mode:
Use a pin to poke the [Reset] button of the camera, the camera's LED light will switch to blue running effect when it enters the pairing mode. (Note: There are only 15s operation time while entering the pairing mode, after timeout, it will exit the pairing mode automatically, and the LED is not the blue running effect).
- Step 4** Start pairing:
Press and hold the [MENU] key until the indicator of remote control light with steady red. When successful paired, the LED of camera flashes with blue light. If the pairing fails, please repeat steps 2, 3 and 4 to repair.

10 GUI Settings

10.1 Menu

Press [MENU] key under normal image, the screen will display as below:

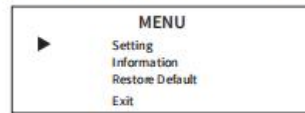

10.2 Setting

Move the cursor to "Setting" in the main menu, and press [OK] to enter the Setting page as below:

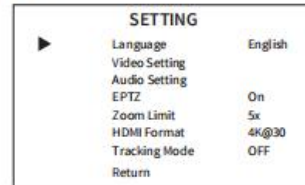

Language: English, Chinese, French.
Video Setting: Press [OK] key to confirm enter the Video Setting page to set the 2D NR, 3D NR, WDR Enable, Flip-H, OSD Mirroring.
Audio Setting: Press [OK] key to confirm enter the Audio Setting page to set the 3A Enable, Mic Equalizer.
EPTZ: On, Off.
Zoom Limit: 1.5x, 2x, 3x, 4x, 5x.
HDMI Format: 1080P60, 1080P50, 1080P30, 4K@30.
Tracking Mode: Off, Participants, Speaker, Smart Gallery.
Tracking Effect: Smooth, Instantaneous (effective only in Participants or Speaker of Tracking Mode).
Tracking Speed: Slow, Normal, Fast (effective only in Participants or Speaker of Tracking Mode).

10.3 Information

Move the cursor to "Information" in the main menu, and press [OK] to enter the Information page as below:

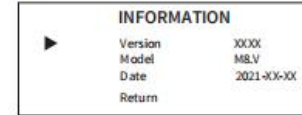

10.4 Restore Default

Move the cursor to "Restore Default" in the main menu, and press [OK] to enter the Restore Default page as below:

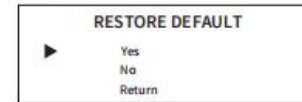

Yes / No: Confirm or cancel restore factory settings.

Note

GUI menu and device information are subject to change without notice.

11 Maintenance & Troubleshooting

Camera Maintenance

- If camera is not use in long-term, please disconnect power switch after use.
- Use soft cloth or cotton paper to remove dust from the camera housing.
- When cleaning the camera lens, please use dry soft cloth to wipe, if dirt is serious, use neutral cleaner gently. Do not use strong or corrosive detergent to avoid lens scratch and affect image effect.

Avoid Using

- Do not shooting particularly bright objects, such as sunlight, lights, etc.
- Do not work under unstable lighting conditions, otherwise the image will flash.
- Do not use around facilities that can transmit high-power radio waves, such as television station or radio-transmitting station.

Troubleshooting

- The monitor shows no image
 - 1) Ensure that the camera power supply is properly connected, the voltage is in normal and the power indicator is always on.
 - 2) Ensure that the cable of video platform and TV in correct connection.
- Image jitters after the camera is properly connected
 - 1) Ensure that the camera installation is in stable position.
 - 2) Check that any vibrating machinery or object near the camera.
- Remote control does not work
 - 1) Check and replace with new batteries.
 - 2) Ensure that the camera working mode is correct.

12 FCC & IC Statement

NOTE: This equipment has been tested and found to comply with the limits for a Class B digital device, pursuant to part 15 of the FCC Rules. These limits are designed to provide reasonable protection against harmful interference in a residential installation. This equipment generates uses and can radiate radio frequency energy and, if not installed and used in accordance with the instructions, may cause harmful interference to radio communications. However, there is no guarantee that interference will not occur in a particular installation. If this equipment does cause harmful interference to radio or television reception, which can be determined by turning the equipment off and on, the user is encouraged to try to correct the interference by one or more of the following measures:

- Reorient or relocate the receiving antenna.
- Increase the separation between the equipment and receiver.
- Connect the equipment into an outlet on a circuit different from that to which the receiver is connected.
- Consult the dealer or an experienced radio/TV technician for help.

Changes or modifications not expressly approved by the party responsible for compliance could void the user's authority to operate the equipment.

This device complies with Part 15 of the FCC Rules. Operation is subject to the following two conditions:

- (1) this device may not cause harmful interference, and (2) this device must accept any interference received, including interference that may cause undesired operation.

This device contains licence-exempt transmitter(s)/receiver(s) that comply with Innovation, Science and Economic Development Canada's licence-exempt RSS(s). Operation is subject to the following two conditions:

- (1) This device may not cause interference.
- (2) This device must accept any interference, including interference that may cause undesired operation of the device.

L'émetteur/récepteur exempt de licence contenu dans le présent appareil est conforme aux CNR d'Innovation, Sciences et Développement économique Canada applicables aux appareils radio exempts de licence. L'exploitation est autorisée aux deux conditions suivantes :

- (1) L'appareil ne doit pas produire de brouillage;
- (2) L'appareil doit accepter tout brouillage radioélectrique subi, même si le brouillage est susceptible d'en compromettre le fonctionnement.