

# 4K UHD Box Camera

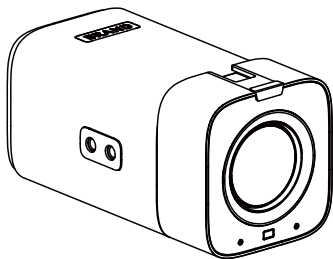
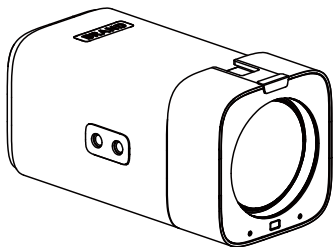

## User Manual

## 1 Safety Precautions

- During the installation and use of the product, strict compliance with the electrical safety regulations of the country and the specific region is required.
- Please use the power adapter provided with this product.
- Do not connect multiple devices to the same power adapter (exceeding the adapter's load capacity may generate excessive heat or cause a fire).
- Do not manually rotate the camera head, as it may cause mechanical malfunctions.
- When installing this product with a tripod, ensure that the product is securely fixed, and do not power it on until all installations are complete.
- To prevent heat buildup, maintain proper ventilation around the product.
- If the product emits smoke, strange odors, or unusual noises, immediately turn off the power, unplug the power cord, and contact the dealer promptly.
- This product is not waterproof; please keep it dry.
- This product has no user-serviceable parts. Damages resulting from user disassembly are

not covered by the warranty.



### Notice

Specific frequencies of electromagnetic field may affect the image of the camera!

## 2 Pack List

Name	Quantity
Camera	1
Power Adapter	1
Installation Bracket (Optional)	1
Remote Control (Optional)	1
Light (Optional)	1
User Manual	1

## 3 About Product

### 3.1 Features

- **4KP60 UHD**

A full-frame rate ultra-high-definition solution for clearer and smoother visuals.

- **12x/20x Optical Zoom**

Use 72.8° or 61.2° high quality super telephoto lens, support 12x or 20x optical zoom.

- **On-body Buttons**

Convenient for customers to perform common camera functions on-site, reducing dependence on the remote control.

- **1080P60 SDI**

1080P60 SDI output better meets the requirements of the professional field for image clarity and smoothness.

- **Multiple Interfaces**

Supports HDMI, SDI, USB, and network outputs, adapting well to

diverse application scenarios.

- **TOF**

Supports Time-of-Flight (TOF) module to improve close-range focusing speed, enhancing the user experience.

- **Built-in Microphone**

Integrated microphone array with omnidirectional sound pickup, pickup range of up to 6 meters, and a unique noise suppression algorithm for perfect voice reproduction.

- **Dual Infrared Receivers**

Front and rear dual infrared perception design significantly expands the infrared reception range, enhancing the remote control operating experience.

### 3.2 Interfaces and Keys

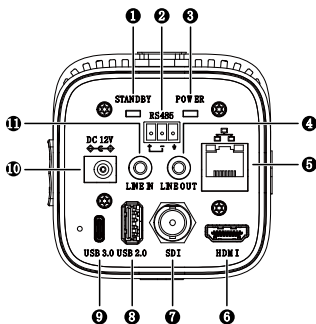

## Manual

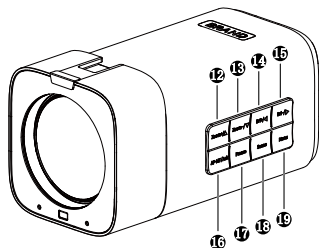

15	Bri-/Menu ▶ Key
16	Auto/Manual Focus Key
17	Freeze Key
18	Scene Key
19	Menu Key

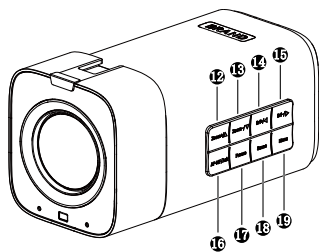

No.	Name
1	STANDBY Indicator
2	RS485 Interface
3	POWER Indicator
4	LINE OUT Interface
5	LAN Interface
6	HDMI Interface
7	SDI Interface
8	USB 2.0 Interface
9	USB 3.0 Interface
10	DC 12V Interface
11	LINE IN Interface
12	Zoom+/Menu ▲ Key
13	Zoom-/Menu ▼ Key
14	Bri+/Menu ◀ Key

### 3.3 Dimension

Unit: mm

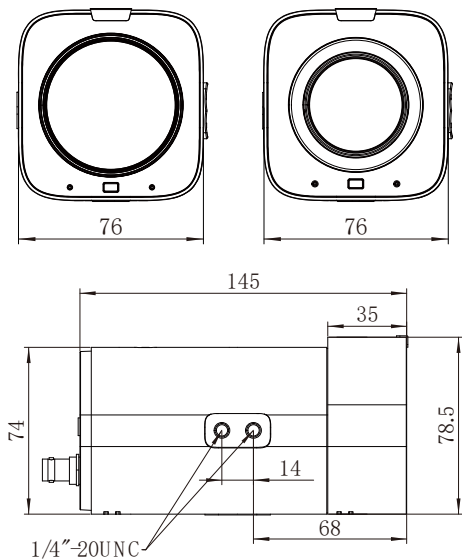

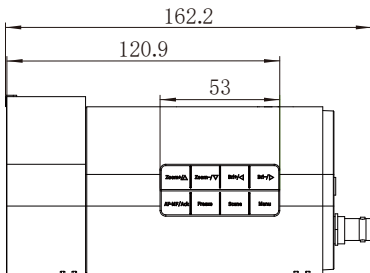

## 4 Product Installation

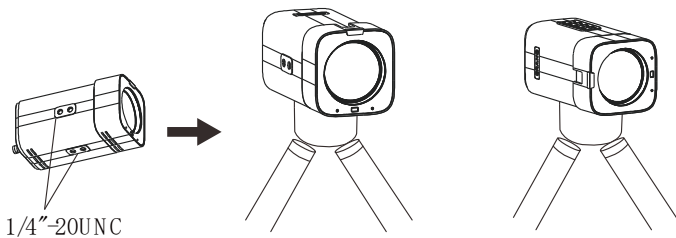

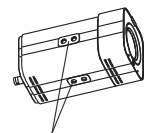
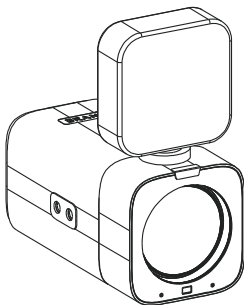
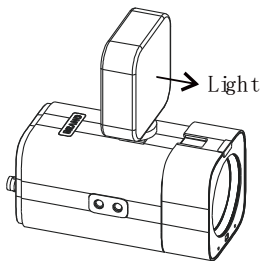

1/4"-20UNC

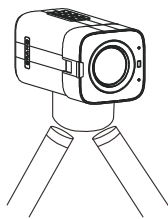
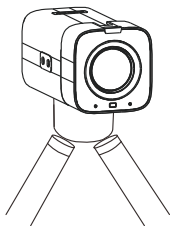

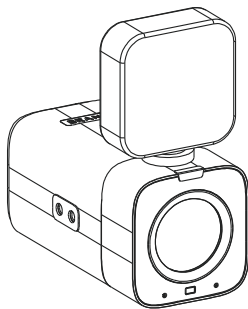
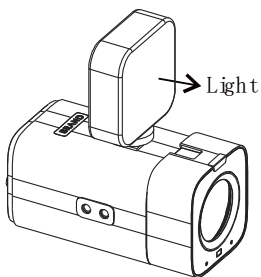
**Note**

- Mounting brackets and screws are optional accessories.
- Light is an optional accessory.

## 5 Product Connection

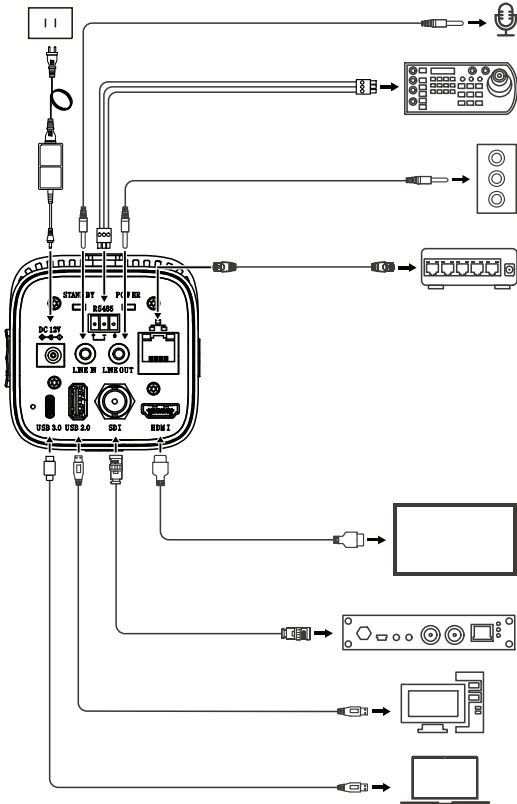

The schematic diagram is for reference only. Please refer to the actual

application scenario for product connection.

## 6 Remote Control

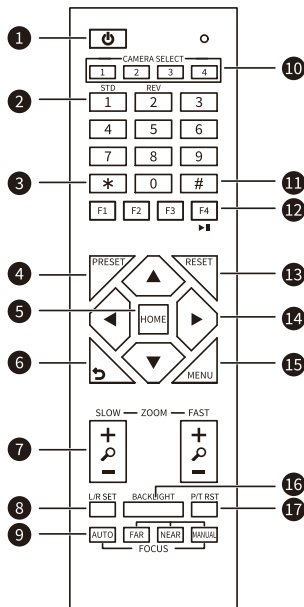

### Key Description

#### 1. ⏻ Standby/Power On Key

In standby, press to power on;  
After power on, press to enter  
standby

#### 2. Number Keys

To set preset or call preset

#### 3. \*Key

Use with other keys

#### 4. PRESET Key

Set preset: Successively press  
[PRESET] + Number key (0-9)

#### 5. HOME Key

Confirm selection or press to turn  
camera lens back to the middle  
position

#### 6. ↵ (Return) Key

Press to return to the previous  
menu

#### 7. ZOOM Keys

SLOW: Zoom In [+] or Zoom Out  
[-] slowly

FAST: Zoom In [+] or Zoom Out [-]  
fast

#### 8. L/R SET Key

Standard: Simultaneously press  
[L/R SET] + 1

Reverse: Simultaneously press  
[L/R SET] + 2

#### 9. FOCUS Keys

Auto/Manual/Far/Near Focus

#### 10. CAMERA SELECT Keys

Press to select and control the  
camera

#### 11. # Key

Use with other keys

#### 12. IR Remote Control Key

Successively press [\*] + [#] +  
[F1]/[F2]/[F3]/[F4]: Set address  
of the camera 1/2/3/4. If you want  
to control, press 1/2/3/4 in  
"CAMERA SELECT".

#### 13. RESET Key

Clear preset position: Successively  
press [RESET] + Number key (0-9)

#### 14. Direction Control Key

After zooming, move the lens in  
the direction indicated by the

---

arrow

---

**15. MENU Key**

---

Press to enter or exit OSD Menu

---

**16. BACKLIGHT Key**

---

Turn on/off backlight  
compensation

---

**17. P/T RST Key**

---

It only applicable to the PTZ  
camera

---

**Note**

Remote control is an optional  
accessory.

## 7 Maintenance and Troubleshooting

---

### Camera Maintains

- If camera will not be used for a long time, please turn off power switch, disconnect AC power cord of AC adapter to the outlet.
- Use soft cloth or tissue to clean the camera cover.
- Please use the soft dry cloth to clean the lens. If the camera is very dirty, clean it with diluted neuter detergent. Do not use any type of solvents, which may damage the surface.

### Unqualified Application

- Do not shooting extreme bright object for a long period of time, such as sunlight, illuminant, etc.
- Do not operating in unstable lighting conditions, otherwise image will be flickering.
- Do not operating close to powerful electromagnetic radiation, such as TV station or radio transmitters, etc.

### Troubleshooting

#### Image

- The video image displayed by the camera lens is jittery
  - 1) Check whether the camera installed position be stabled.
  - 2) Check whether have vibrating machinery or object near the camera.
- There is no video image in browser

That do not support IE browser and IE core browser, it is recommended to use Google, Firefox and Edge browsers. The camera video image will be displayed normally.

- Unable to access camera through browser
  - 1) Using PC to access the network to test that the network access can work properly to eliminate the network fault caused by cable and PC virus until the PC and camera can ping each other.
  - 2) Disconnect the network, connect camera and PC separately, and reset the IP address of PC.
  - 3) Ensure that the IP address, subnet mask and gateway settings is correct.
  - 4) Check whether the MAC address is conflicts.
  - 5) Check whether the web port is modified, the default web port is 80.
- Forget the IP address or login password

Default camera IP: 192.168.100.99.

Default username: admin.

Default password: admin.